

RECESSED

The CLAP'N FIT Gola Profile range is designed, manufactured and PATENTED by Volpato in Italy. The profile can be rapidly fitted in both horizontal and vertical applications using the patented Clap and Fit mounts, saving time and money in the manufacturing process. This extrusion comes in five modern and popular finishes and two different heights, 48mm (top profile) and 66mm (Middle Profile), both supplied in extra-long 4.2m lengths to minimize wastage.

FINISHES:



Natural Anodised



Stainless Steel

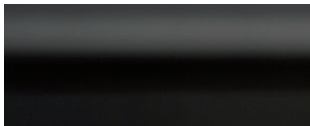

Matt Black

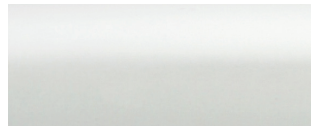

Appliance White



Raw

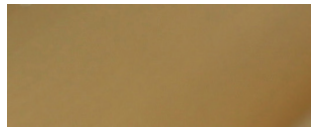

Brass

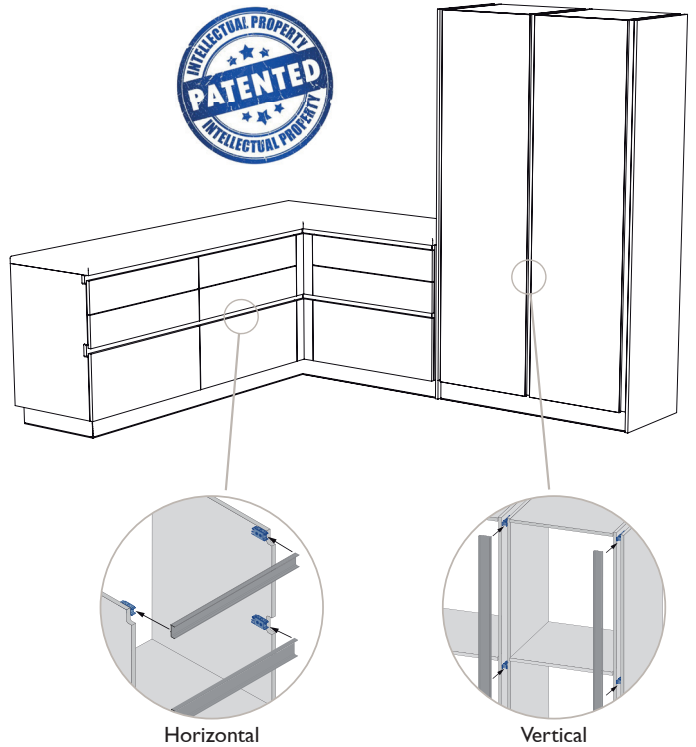

MADE IN ITALY



Featuring the Gola Extrusion Handle

GOLA EXTRUSION

4.2m Lengths, available in single lengths or in packs of 10 lengths

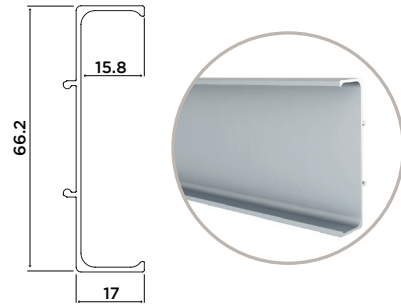
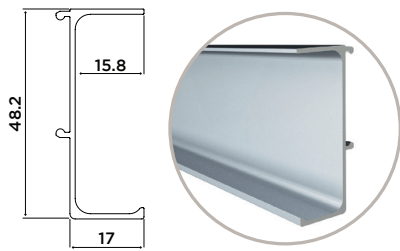

FINISH	48mm Code
Appliance White	VGOLA.W.48
Matt Black	VGOLA.BK.48
Natural Anodised	VGOLA.AN.48
Raw	VGOLA.RAW.48
Stainless Steel	VGOLA.SS.48
Brass	VGOLA.BR.48

FINISH	66mm Code
Appliance White	VGOLA.W.66
Matt Black	VGOLA.BK.66
Natural Anodised	VGOLA.AN.66
Raw	VGOLA.RAW.66
Stainless Steel	VGOLA.SS.66
Brass	VGOLA.BR.66

GOLA FIXING BRACKET

Available in packs of 10

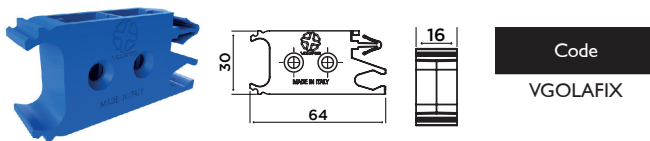

EXTERNAL END CAPS

Available in sets - 1 left hand and 1 right hand

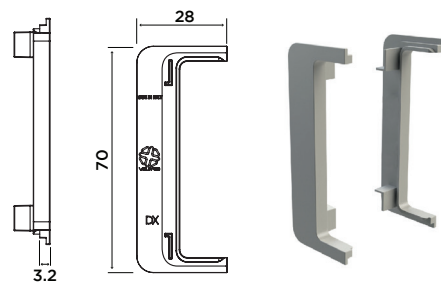
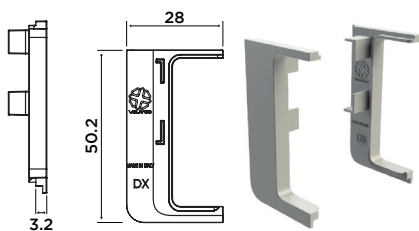

FINISH	48mm Code
Appliance White	VGOLA.W.48END
Matt Black	VGOLA.BK.48END
Natural Anodised	VGOLA.AN.48END
Stainless Steel	VGOLA.SS.48END

FINISH	66mm Code
Appliance White	VGOLA.W.66END
Matt Black	VGOLA.BK.66END
Natural Anodised	VGOLA.AN.66END
Stainless Steel	VGOLA.SS.66END

INTERNAL END CAPS (FULL)

Available in sets - 1 left hand and 1 right hand

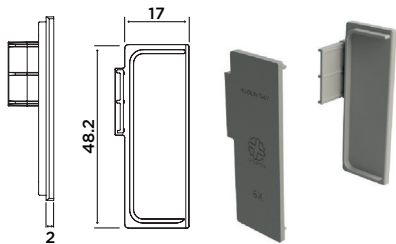

FINISH	48mm Code
Appliance White	VGOLA.W.48INTEND
Matt Black	VGOLA.BK.48INTEND
Natural Anodised	VGOLA.AN.48INTEND
Stainless Steel	VGOLA.SS.48INTEND
Brass	VGOLA.BR.48INTEND

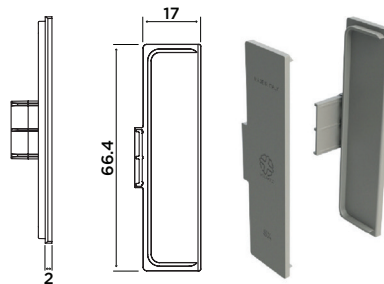

FINISH	66mm Code
Appliance White	VGOLA.W.66INTEND
Matt Black	VGOLA.BK.66INTEND
Natural Anodised	VGOLA.AN.66INTEND
Stainless Steel	VGOLA.SS.66INTEND
Brass	VGOLA.BR.66INTEND

EXTERNAL END CAPS (FULL)

Available individually

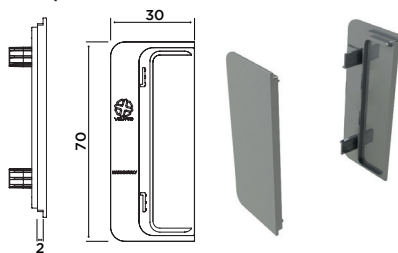

FINISH	66mm Code
Appliance White	VGOLA.W.66EXTEND
Matt Black	VGOLA.BK.66EXTEND
Natural Anodised	VGOLA.AN.66EXTEND
Stainless Steel	VGOLA.SS.66EXTEND



INTERNAL JOIN 45 CORNERS

Available individually

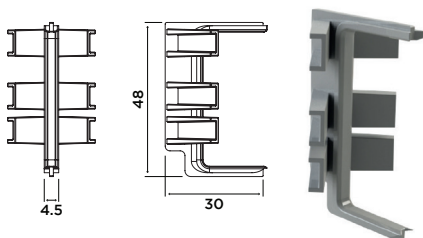

FINISH	48mm Code
Appliance White	VGOLA.W.48CNR45I
Matt Black	VGOLA.BK.48CNR45I
Natural Anodised	VGOLA.AN.48CNR45I
Stainless Steel	VGOLA.SS.48CNR45I

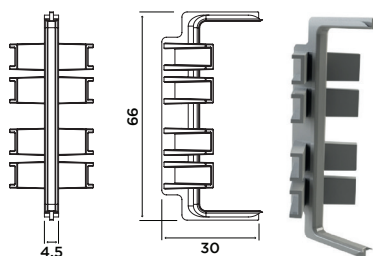

FINISH	66mm Code
Appliance White	VGOLA.W.66CNR45I
Matt Black	VGOLA.BK.66CNR45I
Natural Anodised	VGOLA.AN.66CNR45I
Stainless Steel	VGOLA.SS.66CNR45I

EXTERNAL JOIN 45 CORNERS

Available individually

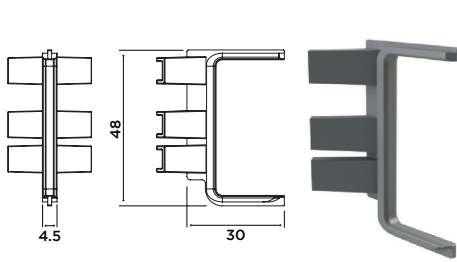

FINISH	48mm Code
Appliance White	VGOLA.W.48CNR45E
Matt Black	VGOLA.BK.48CNR45E
Natural Anodised	VGOLA.AN.48CNR45E
Stainless Steel	VGOLA.SS.48CNR45E

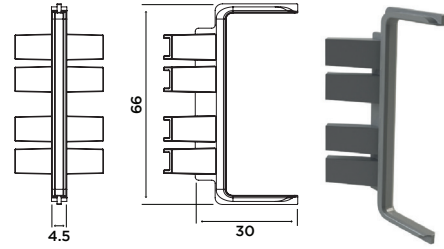

FINISH	66mm Code
Appliance White	VGOLA.W.66CNR45E
Matt Black	VGOLA.BK.66CNR45E
Natural Anodised	VGOLA.AN.66CNR45E
Stainless Steel	VGOLA.SS.66CNR45E

INTERNAL JOIN 90 CORNERS

Available individually

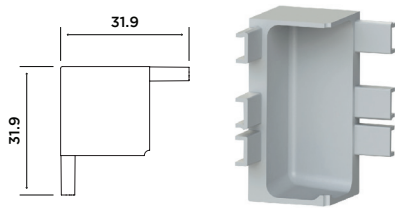

FINISH	66mm Code
Appliance White	VGOLA.W.48CNR90I
Matt Black	VGOLA.BK.48CNR90I
Natural Anodised	VGOLA.AN.48CNR90I
Stainless Steel	VGOLA.SS.48CNR90I

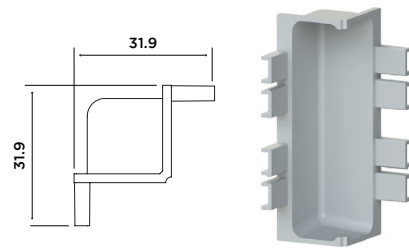

FINISH	66mm Code
Appliance White	VGOLA.W.66CNR90I
Matt Black	VGOLA.BK.66CNR90I
Natural Anodised	VGOLA.AN.66CNR90I
Stainless Steel	VGOLA.SS.66CNR90I

EXTERNAL JOIN 90 CORNERS

Available individually

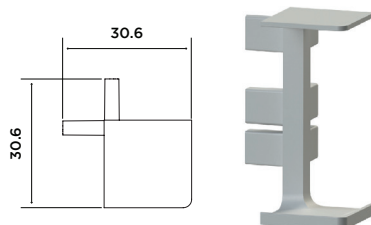

FINISH	48mm Code
Appliance White	VGOLA.W.48CNR90E
Matt Black	VGOLA.BK.48CNR90E
Natural Anodised	VGOLA.AN.48CNR90E
Stainless Steel	VGOLA.SS.48CNR90E

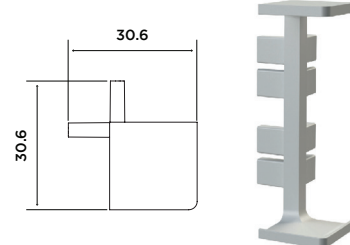

FINISH	66mm Code
Appliance White	VGOLA.W.66CNR90E
Matt Black	VGOLA.BK.66CNR90E
Natural Anodised	VGOLA.AN.66CNR90E
Stainless Steel	VGOLA.SS.66CNR90E